

FLÄKT WOODS LIMITED

FANS IN FIRE SAFETY

SMOKE CONTROL
BY
PRESSURISATION

By: J.A. WILD, C.ENG; F.I.MECH.E.

November 1998
(Third Edition)

© Copyright 2000 Fläkt Woods Limited England.

AIRTREND Ltd.
Predstavništvo u Beogradu
Kumanovska 14, 11000 Beograd
Tel: 011/3836886, 3085740
Faks: 011/3444113
e-mail: gobrid@eunet.rs
web: www.airtrend.rs

The logo for FläktWoods, featuring the word "Fläkt" in a bold, green, sans-serif font, followed by "Woods" in a similar font. A green swoosh underline is positioned beneath "Fläkt", and a green curved line is positioned above "Woods".

CONTENTS

		PAGE NO:
Summary		4
Chapter One	Smoke Control By Pressurisation - Basics	5 - 6
Chapter Two	Why Pressurisation?	7 - 8
Chapter Three	The Pressurisation System	9 - 16
Chapter Four	Air Requirements of a Pressurisation System	17- 20
Chapter Five	Fan Selections	21- 27
Chapter Six	Fans for Pressurisation Systems	28 - 29
Appendix One	References	30

ACKNOWLEDGEMENTS

The author wishes to acknowledge the assistance he received from Mr Cyril Moss, KG Smoke Dispersals Ltd and Mr E Gordon Butcher of Fire Check Consultants with the preparation of this paper.

WOODS AIR MOVEMENT LIMITED

Fans for Pressurisation Systems

By: J.A. WILD, C.ENG; F.I.MECH.E.

SUMMARY

There are basically two main methods for controlling smoke in buildings to prevent it contaminating escape routes - by Ventilation and by Pressurisation.

Fans for Fire Smoke Venting (Ref 1) examines the motivation behind the increased use of Powered Ventilators for the exhausting of hot smoke from fires and determines their requirements and specifications.

This paper undertakes a similar task to determine the requirements and specification for FANS IN PRESSURISATION SYSTEMS, based on the requirements of BS5588 Part4:1998.

CHAPTER 1

Smoke Control By Pressurisation - Basics

1.1 BASIC PRINCIPLES

Fire induced forces create pressure differences across doors etc, which allow smoke to flow through any gaps present.

By altering these pressure differences we can control the movement of smoke.

The two BASIC PRINCIPLES of smoke control were defined by JH KLOTE (Ref 2) as:-

- a) Airflow can control smoke movement if the average VELOCITY is of sufficient magnitude.
- b) A PRESSURE difference across a barrier can act to control smoke movement.

Although the second of these principles can be taken as a special case of the first, when dealing with them as an engineering problem it is easier to take the two separately viz:-

Large Gaps- Open Door etc - VELOCITY
Small Gaps - Closed Door etc - PRESSURE

These, then are the BASIC PRINCIPLES which control the design and ultimately the satisfactory functioning of a PRESSURISATION SYSTEM for SMOKE CONTROL. They formed the basis of the British Standard Codes of Practice - BS5588 Parts 4:1978 and 5:1991, and the same elements can be seen in many of the various national standards listed in TABLE 1.

1.2 SUPPLY AIR PARAMETERS

The two parameters which have the greatest effect on the size of the supply fan are:-

- a) The AIR VELOCITY through the OPEN DOORS.
- b) The number of EFFECTIVE OPEN DOORS

a) Door Velocity

Thomas' correlation (Ref 3) estimates that a 2.4 MW fire will cause smoke to flow through a 0.9 metre wide opening at 3-4 m/sec. BS5588 Part 4:1978 requires this for permanent openings.

In practice a velocity of this magnitude is virtually impossible to achieve in the type of buildings using Pressurisation for Smoke Control, and some compromise is necessary. Doors are considered as only being opened intermittently and hence VELOCITIES can be reduced.

Table 1 shows VELOCITIES between 0.75 m/sec and 2.0 m/sec.

BS5588 Part 4:1978 specified up to 0.75 m/sec during the Escape period.

BS5588 Part 5:1991 - 2.0 m/sec for Fire Fighting.

b) Number of Open Doors

Variations in this parameter have the greatest effect on fan size.

Again table 1 shows much variation from ONE EFFECTIVE DOOR OPEN specified by BS5588 Part 4 1978 to FOUR EFFECTIVE DOORS OPEN required by the CANADIAN STANDARD - N.B.C.C. 1990.

However the combination of DOOR VELOCITY and DOORS OPEN likely to produce the greatest air supply requirement is that specified by BS5588 Part 5 1991 - 2.0 m/sec with TWO EFFECTIVE DOORS OPEN.

1.3 RECENT DEVELOPMENTS

BS5588 Part 4 - 1978 was revised and re-issued during April 1998

The revised Code Practice designated BS5588: Part 4: 1998, retains the

0.75m/sec air velocity through the open door(s) onto the fire floor during the **escape** phase, but now demands that up to three effective doors be regarded as being OPEN when calculating the supply air quantity required. The number of open doors varies with the type and usage of the building, but in general, this change from 1978 code will increase the quantity of supply air required.

In addition, BS5588: Part 4: 1998 incorporates the Pressurisation System requirements for Fire Fighting specified in BS5588: Part 5 1991 and it is still this requirement - 2.0m/sec with up to **THREE EFFECTIVE DOORS OPEN** which produces the greatest air supply demand.

The discussion and calculations in this revised paper are now based on the requirements of BS5588: Part 4: 1998.

TABLE 1 - COMPARISON OF VARIOUS CODES OF PRACTICE

Country	Code	Pressure (Pa)		Door Velocity	No. Of Effective Open Doors
		Min.	Max.		
U.K.	BS5588 Part 4:1978	50	60	0.75 m/sec	ONE (2 Doors on Fire Floor)
	BS5588 Part 5:1991	Not Relevant		2.00 m/sec	THREE (2 Doors on Fire Floor) (Exit and Lift Door)
Australia	AS1668 P.1	50	110	1.00 m/sec	THREE (2 Doors on 2 Floors) (Exit Door)
Singapore	CP13	50	110	1.00 m/sec	THREE (2 Doors on 2 Floors) (Exit Door)
Canada	N.B.C.C. 1990	No Mention		4.72 m ³ /sec + 0.094 m ³ /sec For every door	FOUR (2 Doors on 3 Floors) (Exit Door)
U.S.A.	U.B.C. 1988	37	-	No Mention	No Mention
	N.F.P.A. (92A) 1988	up to 45	133	No Mention	No Mention
U.K.	BS5588 Part 4: 1998	50	60	ESCAPE STAIRS 0.75m/sec	ONE (Class A & C System) TWO (Class D System) THREE (Class E system)
				Fire Fighting 2.00m/sec	THREE (Class B System)

CHAPTER 2

Why Pressurisation?

2.1 OBJECTIVE OF SMOKE CONTROL

The objective of any SMOKE CONTROL system is to keep the smoke and toxic gases out of the escape route long enough to allow the occupants to escape or seek a safe refuge. In addition an adequate smoke control system will help the fire fighters deal both with the fire and any residue smoke.

2.2 SMOKE VENTILATION

In large open spaced buildings, CAR PARKS, SHOPPING CENTRES, EXHIBITION HALLS etc, the usual method of smoke control is by ventilation - extracting the smoke from the area.

Major development work on Axial Flow Fans for the venting of hot fire smoke was carried out during the 1980's (Ref 4), which led to the publication in 1990 of a test standard BS7346 Part 2 (Ref 5).

In high rise, multi room buildings, where the Staircases, Lift Lobbies and Corridors provide the escape route, SMOKE EXTRACTION may only serve to worsen the situation.

A SMOKE EXTRACTION system, illustrated in Fig 1, will provide negative pressure in the escape routes which will tend to draw the smoke into the very spaces requiring protection.

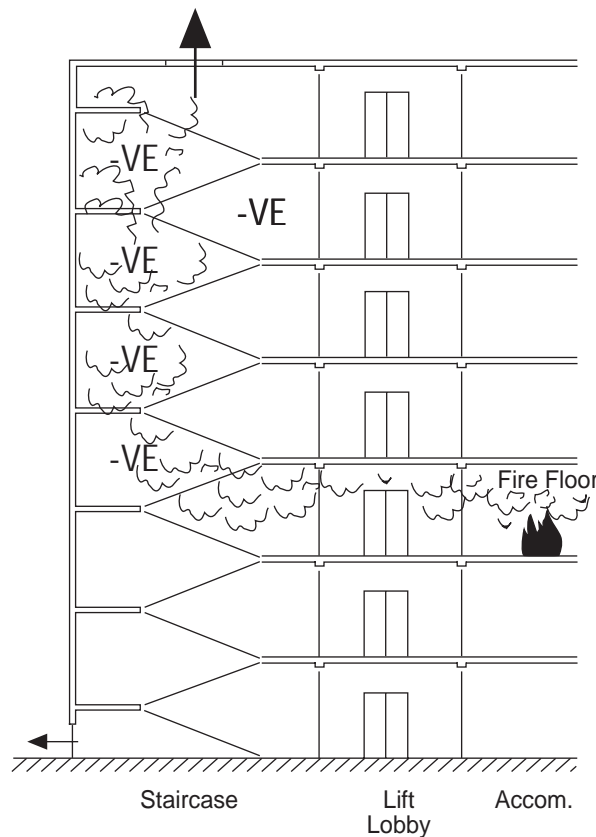

Fig 1 - Smoke Control by Ventilation

2.3 PRESSURISATION

However, it is possible to hold back smoke from a fire by simply supplying clean air into the escape routes, thereby developing excess, or POSITIVE pressure in the spaces requiring protection.

Fig 2, illustrates this method which is known as PRESSURISATION.

In a PRESSURISATION SYSTEM the air-flow must always be away from the escape routes to ensure that they will be at a higher pressure than the surrounding area.

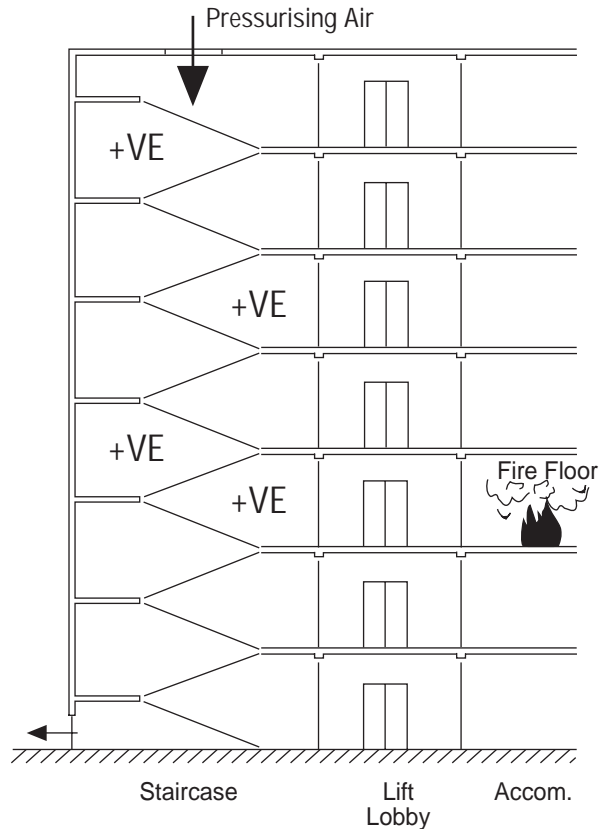

Fig 2 - Smoke Control by Pressurisation

2.4 HISTORY OF PRESSURISATION SYSTEMS

The idea of PRESSURISATION is not new. For over 50 years PRESSURISATION systems have been used to keep rooms free of dust and harmful contamination, and to provide sterile condition in operating theatres etc.

The use of Pressurisation for SMOKE CONTROL began to be considered during the 1950's, both in the U.K. and Australia.

The first Code of Practice permitting the use of PRESSURISATION as a fire protection method was published in Australia in 1957.

In the U.K. research continued during the 1960's and 1970's (Ref 6) resulting in the publication of a Code of Practice - BS5588 Part 4 in 1978 (Ref 7). This Code of Practice was reviewed and reissued in April 1998 as BS5588:Part 4:1998(Ref 8)

CHAPTER 3

The Pressurisation System

3.1 ELEMENTS OF A PRESSURISATION SYSTEM

A pressurisation System has two main components as illustrated in Fig 3.

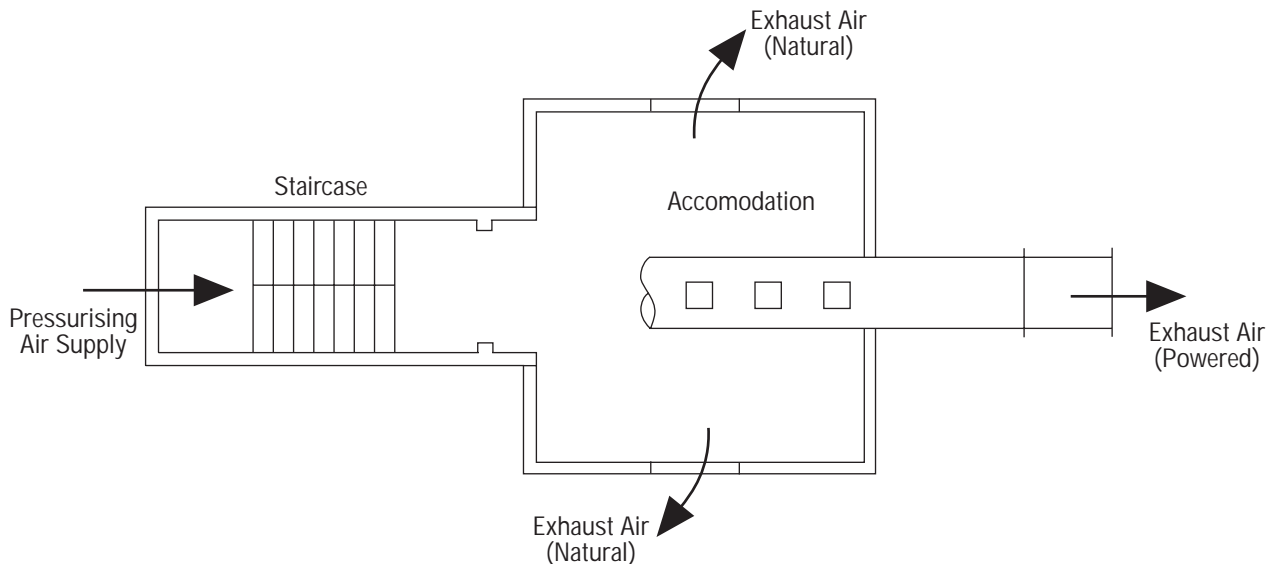

Fig 3 - Elements of a Pressurisation System

- a) A Supply Air System designed to blow into the protected spaces a sufficient quantity of air to maintain the required pressure level or air velocity.

This will always be fan powered.

- b) An Exhaust Air System to enable the pressurising air to escape from the unpressurised areas of the building via the fire floor.

This can be either a natural or fan powered method. The fans used would be required to handle the hot fire smoke and comply with BS7346 Part 2 (Ref 5).

3.2 SUPPLY AIR SYSTEM

A pressurisation system has TWO and occasionally THREE, modes of operation.

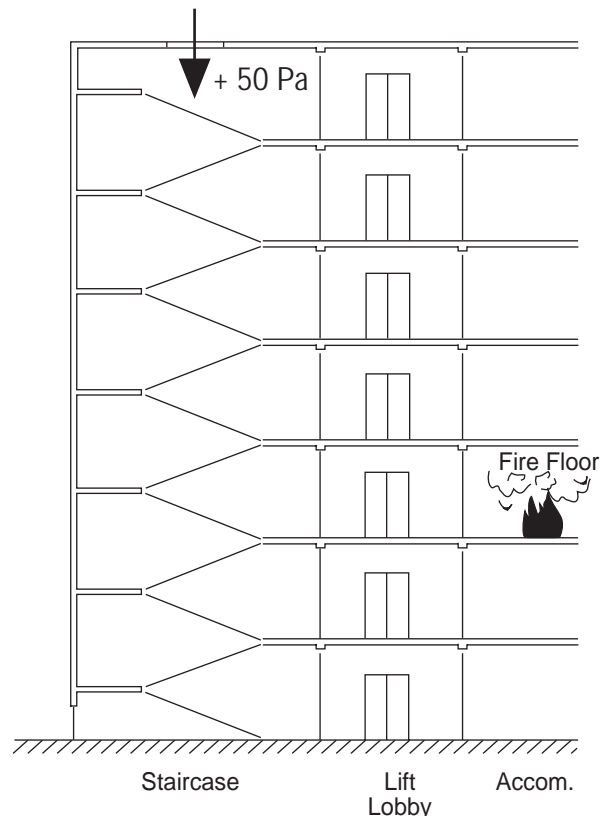

Fig 4 - Detection Phase - All Doors closed (Mode 1)

Mode 1 - DETECTION PHASE - To raise a pressure differential in the protection space - staircase, corridor etc, by the required amount (50Pa in the UK) when ALL DOORS ARE CLOSED.

Mode 2 - ESCAPE PHASE - To maintain a specified AIR VELOCITY (0.75m/sec) through the OPEN DOOR(S) onto the fire floor with various other doors open, OR a PRESSURE DIFFERENCE OF 10+ Pa with the fire floor door(s) closed and various other doors open (fig 7-9)

Mode 3 - FIRE FIGHTING PHASE - To maintain a specified AIR VELOCITY (2.0 m/sec) through the OPEN DOOR(S) onto the fire floor with various other doors open.

ALL pressurisation systems for SMOKE CONTROL have a Detection Phase (Mode 1)

The new BS5588: Part 4: 1998 now classifies the ESCAPE PHASE (Mode 2) relative to building type and use.

System Class	Area of use
A	Residential, sheltered housing and buildings designed for three door protection (Fig 5)
B	Protection of firefighting shafts (Fig 6)
C	Commercial premises (using simultaneous evacuation)(Fig 7)
D	Hotels, hostels and institutional-type buildings, excluding buildings designed to meet call A (Fig 8)
E	Phased evacuation (Fig 9)

TABLE 2 - Classification of Buildings for Smoke Control using Pressure Differentials

The Fire Fighting (Mode 3), is included in the classification. The system requirement, taken from BS5588:Part 5:1991 remain common to all building types.

A notable addition in the new code of practice is that CLASS C; E; and D systems have BOTH a VELOCITY and PRESSURE CRITERION requirement during the Escape Phase (Mode 2)

These CLASSES of Pressurisation Systems are detailed in TABLE 2 and their individual requirements are discussed below.

CLASS "A" SYSTEMS - ESCAPE PHASE - (MODE 2)

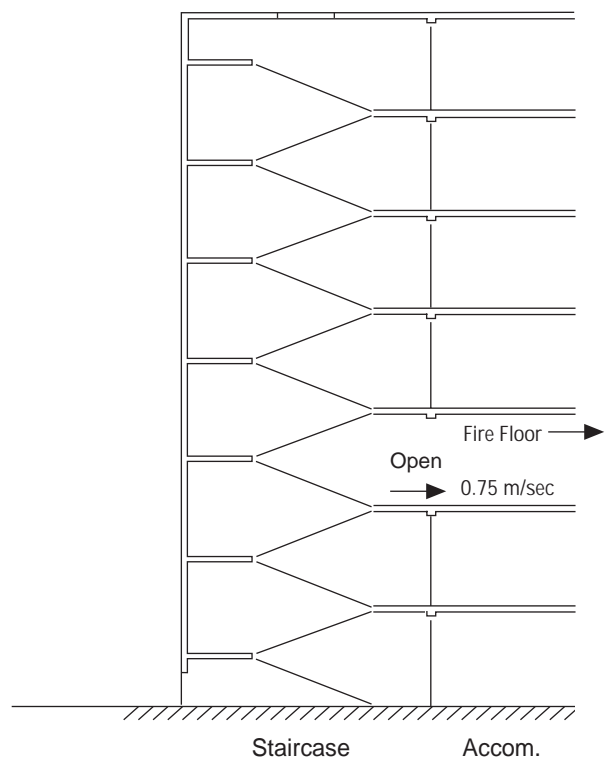
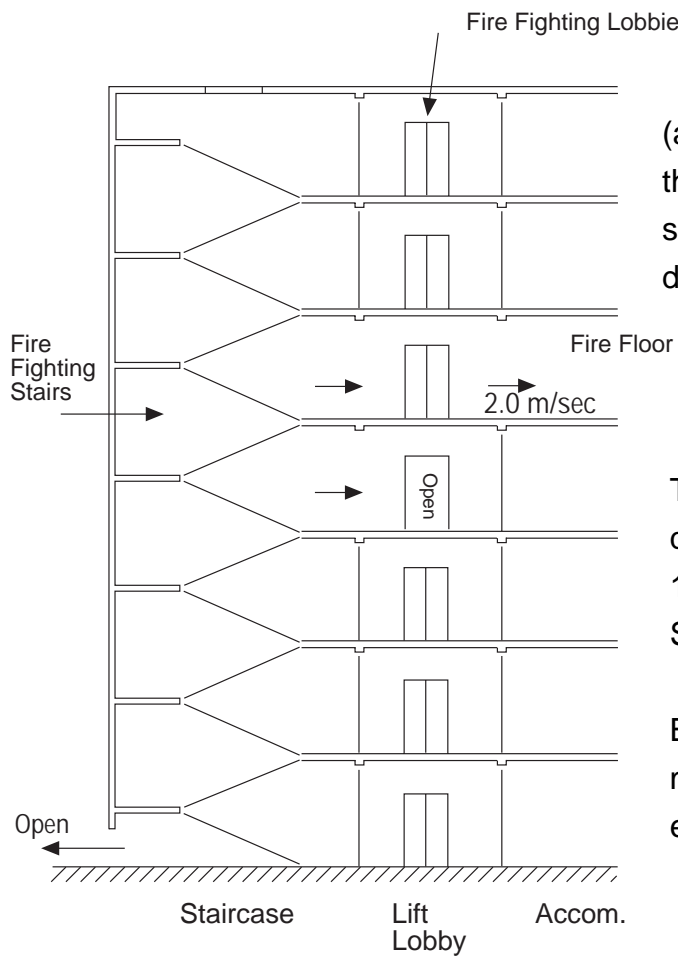

Fig 5 - Velocity Criterion

To generate an air velocity of 0.75m/sec through the open door(s) out of the pressurised space onto the fire floor (fig. 5)

**CLASS "B" SYSTEMS - FIRE FIGHTING
PHASE - MODE 3**



(a) To generate an air velocity of 2.0m/sec through the open door(s) out of the Pressurised space onto the fire floor with the door status shown in Fig. 6.

This will establish the pressurisation requirement specified in BS5588 - Part 5: 1991 (Ref: 9) now included as Class "B" Systems in BS5588: Part 4:1998.

BS5588: Part 5: 1991, provides recommendations for the design of stair and lifts etc., to be used by fire-fighters.

Fig. 6 - Velocity Criterion

**CLASS 'C' SYSTEMS - ESCAPE PHASE
- (MODE 2)**

(a) To generate an air velocity of 0.75m/sec through the open door(s) out of the pressurised space onto the fire floor (**Fig 7a**).

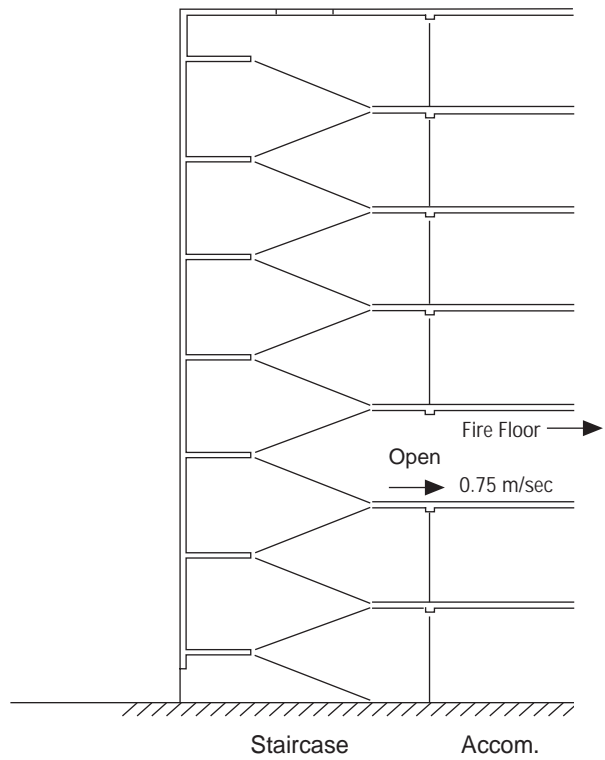

Fig. (7a) - Velocity Criterion

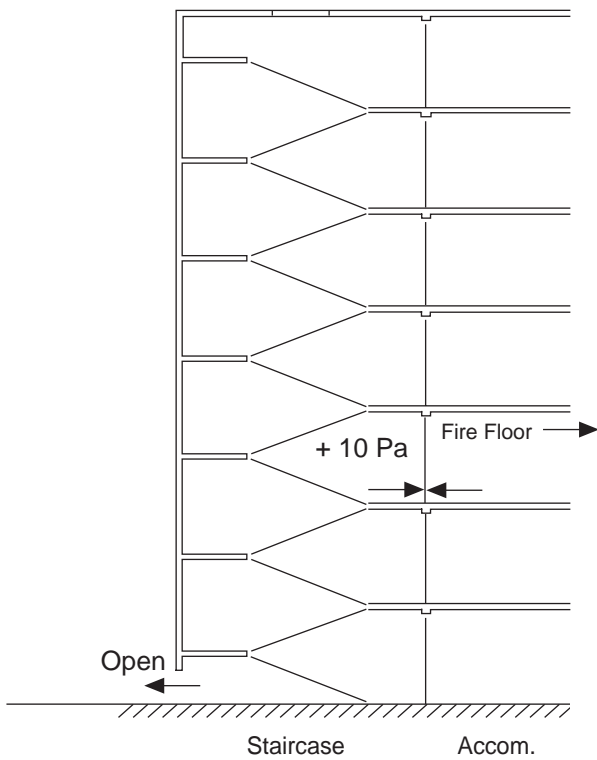

Fig. (7b) - Pressure Criterion

(b) To maintain a pressure difference of +10Pa across the closed fire door with the final exit door open (**fig 7b**).

CLASS "D" SYSTEMS -ESCAPE PHASE - (MODE 2)

(a) To generate an air velocity of 0.75m/sec through the open door(s) out of the pressurised space onto the fire floor with the final exit door open (Fig. 8a)

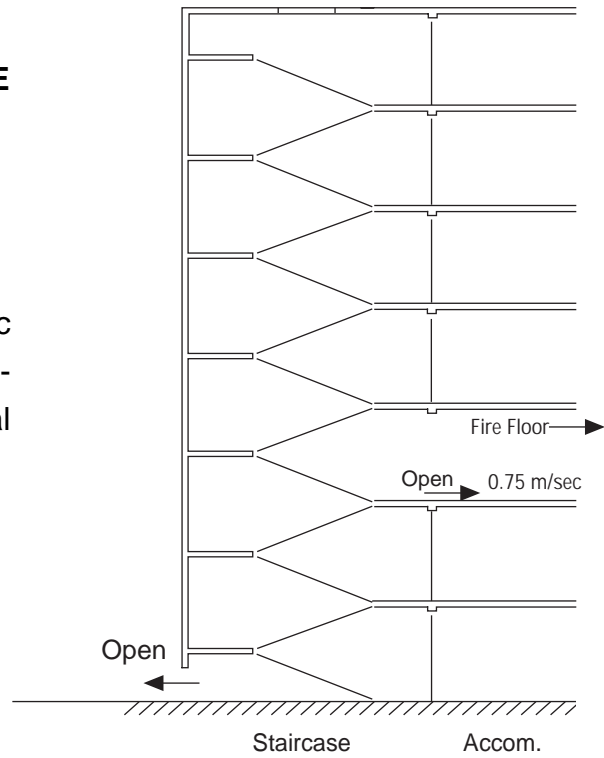
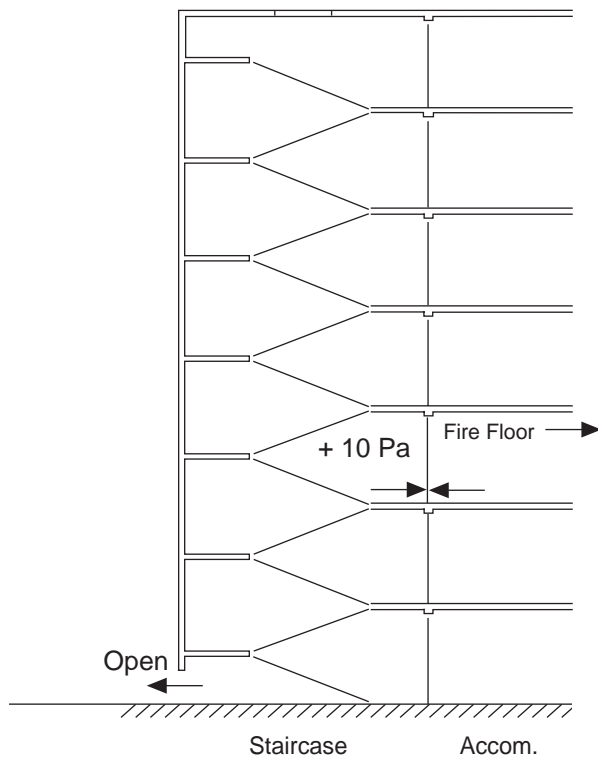

Fig. (8a) -Velocity Criterion



(b) To maintain a pressure difference of +10Pa across the closed fire door with the final exit door open (**Fig. 8b**)

Fig. (8b) - Pressure Criterion

3.3 EXHAUST AIR SYSTEM

The EXHAUST AIR system must be designed to provide a LOW RESISTANCE route for the supply air to leave the building via the fire floor.

This can be achieved by one of four methods:-

- a) Via the leakage provided by the window cracks on the outside of the building.

In practice this is unrealistic. The area provided is unlikely to be sufficient.

- b) Through automatically opened windows or vents around the perimeter of the building.

This is a possibility where the area concerned has sufficient outside wall space to accommodate the vent area necessary. Operating Mode 2 would require almost 0.5 m² of vent area on every floor for each pressurised staircase.

- c) The provision of a vertical duct through the building with a damper arranged to open automatically on the FIRE FLOOR. See Fig 10.

This method is often the best solution although to ensure a low resistance path

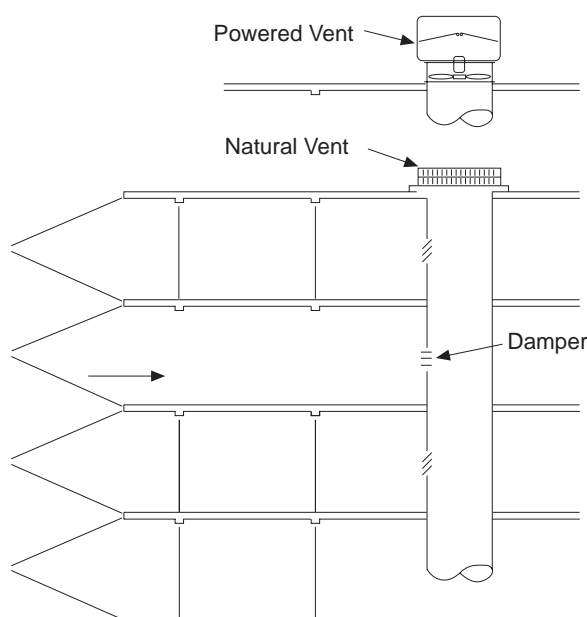

Fig 10 - Exhaust System by Vertical Duct

the size of duct (cross-sectional area) can cause problems.

- d) Mechanical, powered extract from the unpressurised space. This can be achieved by either:-
 - i) Providing the vertical duct Fig 10 with an exhaust fan selected to both overcome the resistance of the duct work and handle the hot smoke. The size of the duct can then be reduced.
 - ii) By utilising any existing mechanical exhaust system from the unpressurised spaces.

A powered exhaust system from the fire room could provide two incremental advantages.

1) The exhaust fan would be selected to overcome any resistance from the exhaust vent or grill. The residue pressure in the staircase, when the doors are open, would be reduced, and with it the quantity of air leaving the building via the final exit door - on systems where this is specified as OPEN. The result would be a reduced quantity of supply air to the system (see also paragraph 5.6)

2) The system can be designed to remove more air than the pressurisation system is supplying. This would tend to create a negative pressure, in the fire area, relative to the rest of the building ensuring that all airflow through the building is towards the fire area. Smoke will thereby be prevented from entering unaffected parts of the building via unidentified leakage paths.

Mechanical exhaust may be the only way of dealing with the high volumes of air exhaust demanded by Class B, D and E System.

3.4 OPERATING LEVELS

The operating status of a pressurisation system can be organised at 2 levels.

LEVEL 1

Plant OFF - except in an emergency
(SINGLE STAGE PRESSURE SYSTEM)

LEVEL 2

Plant ON - running continuously at REDUCED capacity - except in an emergency.
(TWO STAGE PRESSURE SYSTEM).

3.5 SPACES TO BE PRESSURISED

a) STAIRCASE ONLY

The SMOKE CONTROL system will provide protection to the vertical part of the escape route only. It should only be used when the STAIRCASE is entered direct from the accommodation or via a simple lobby (i.e. a lobby without LIFTS, TOILETS or other possible air escape routes) Fig 11.

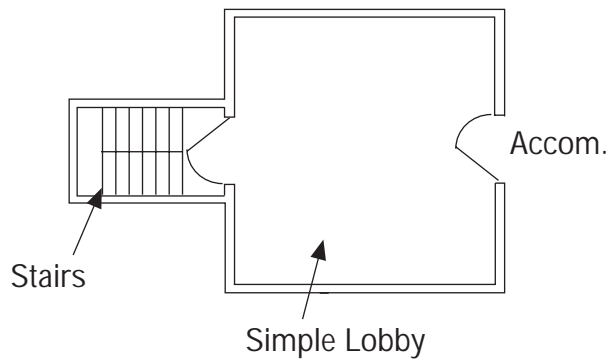

Fig 11 - Staircase With Simple Lobby

b) STAIRCASE & LOBBY

Two duct systems, from a common fan, required both for STAIRCASE and LIFT LOBBY, used where the LOBBY provides outlets from LIFTS, contains TOILETS or other ancillary rooms Fig 12.

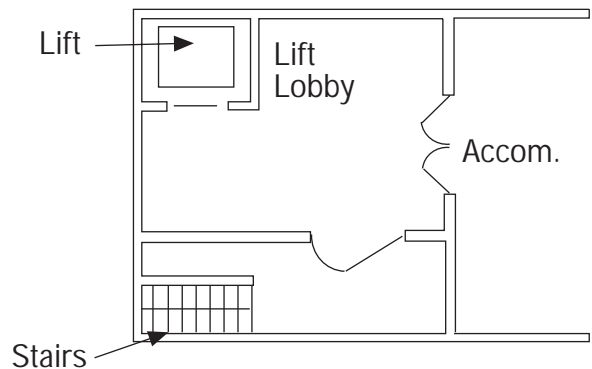

Fig 12 - Staircase With Lift Lobby

c) STAIRCASE, LOBBY & CORRIDOR

Extending the LOBBY pressurisation system into the CORRIDOR using additional outlets in the corridor Fig 13. Used only where the construction of the corridor has a fire resistance of 30 minutes or more.

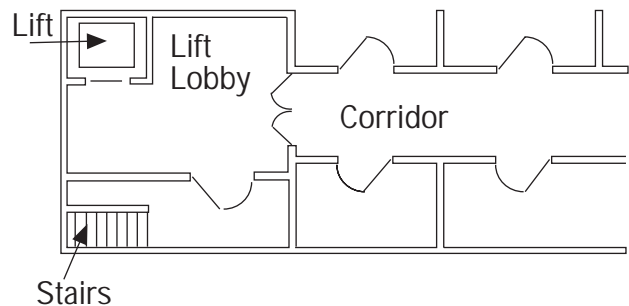

Fig 13 - Stairwell With Lift Lobby & Corridor

d) LIFT SHAFT

Generally only used in Fire Fighting (BS5588 Part 5). The LIFT LOBBY then effectively becomes a simple lobby as far as the staircase pressurisation system is concerned. With the lift shaft pressurised there is no escape path for the air via the lift shaft.

The STAIRCASE and LIFT SHAFT can be pressurised using a common fan with separate ducting.

CHAPTER 4

Air Requirements of a Pressurisation System

4.1 DESIGN BACKGROUND

The design of any air movement system involves an answer to the question:-

“How do I establish the AIR VOLUME required to make this system work?”

With a Pressurisation System designed for SMOKE CONTROL there is an initial question to be answered.

“What PRESSURE (or VELOCITY) do I need to develop in the escape routes to hold back the smoke?”

The answers to both these questions were provided as a result of research work by P.J. Hobson and L. J Stewart in the U.K. during the 1960's and 1970's (Ref 6). This work led directly to the publication of the U.K. code of Practice for Pressurisation Systems - BS5588 Part 4 in 1978 (Ref 7), now superseded by the current code of practice in BS5588 Part 4:1998 (Ref 8).

4.2 PRESSURE LEVELS

Stewart and Hobson studied the factors which can cause smoke to spread around a building. As a result they were able to suggest guidelines for a Pressurisation System designed for SMOKE CONTROL. TABLE 3 details these guidelines.

This established the DESIGN PRESSURE levels of 50 Pa for operating MODE 1 - All Doors Closed - of a system although reduced pressures would be acceptable on buildings of lower height.

4.3 SUPPLY AIR VOLUME

Having established the PRESSURE LEVEL required to hold back the smoke, the AIR VOLUME to be supplied to the escape route to develop this pressure can be calculated.

Again, the formula for doing this comes from the work by HOBSON and STEWART.

$$Q = 0.83 A_E P^{\frac{1}{n}}$$

Q = The volume of air required (m³/sec)

A_E = Leakage area from the space (m²)

P = Pressure differential (Pa)

n = Leakage factor

For large leakage areas - Doors etc - n = 2

For small leakage areas - Window cracks -
n = 1.6

For the purpose of a Pressurisation System designed to hold the smoke behind doors the formula becomes,

$$Q = 0.83 A_E P^{\frac{1}{2}}$$

Building Height (m)	Fire Pressure (Pa)	Wind/Stack Effect (Pa)	Design Pressure (Pa)
5	8.5	8.0	25
25	8.5	10.5	25
50	8.5	13.0	50
100	8.5	19.5	50
150	8.5	29.5	50

Table 3 - Design Pressures

4.4 DOOR LEAKAGE AREA

The effective door leakage areas can be estimated by using the values given in TABLE 4 (Ref 7). These values only apply to the door types and sizes shown.

Type of Door	Size	Crack Length (m)	Leakage Area (m ²)
Single Leaf in Frame Opening into Pressurised Space	2 m x 800 mm	5.6	0.01
Single Leaf in Frame Opening Outwards	2 m x 800 mm	5.6	0.02
Double Leaf with or without Central Rebate	2 m x 1.6 m	9.2	0.03
Lift Door	2 m High x 2 m Wide	8.0	0.06

Table 4 - Typical Leakage Areas Around Doors

For single openings, one door, $A_E =$ nett free area of the opening.

For several openings, or doors, situated in PARALLEL around a pressurised space Fig 11.

$$A_E = A_1 + A_2 + A_3 + A_4 \dots$$

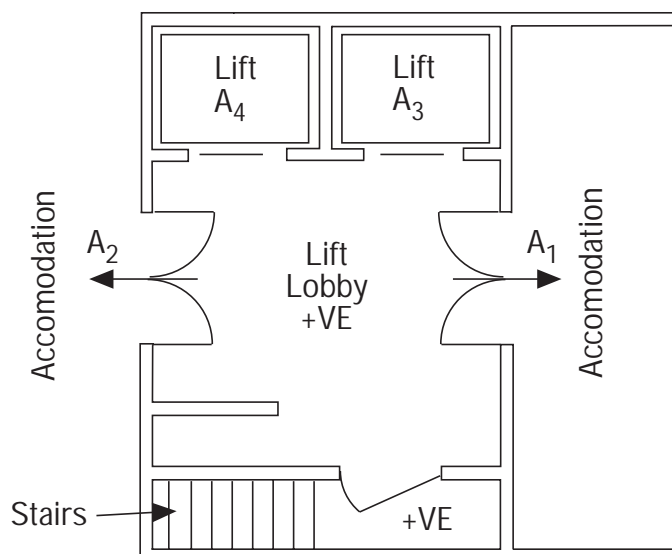

Fig 14 - Doors In Parallel

For several opening - or Doors - situated in SERIES along an escape route - Fig 12.

$$A_E = \left[\frac{1}{(A_1)^2} + \frac{1}{(A_2)^2} + \frac{1}{(A_3)^2} + \frac{1}{(A_4)^2} \dots \right]^{-1/2}$$

For two doors in series more typical of a pressurisation system this simplifies to

$$A_E = \frac{(A_1 \times A_2)}{(A_1^2 + A_2^2)^{1/2}}$$

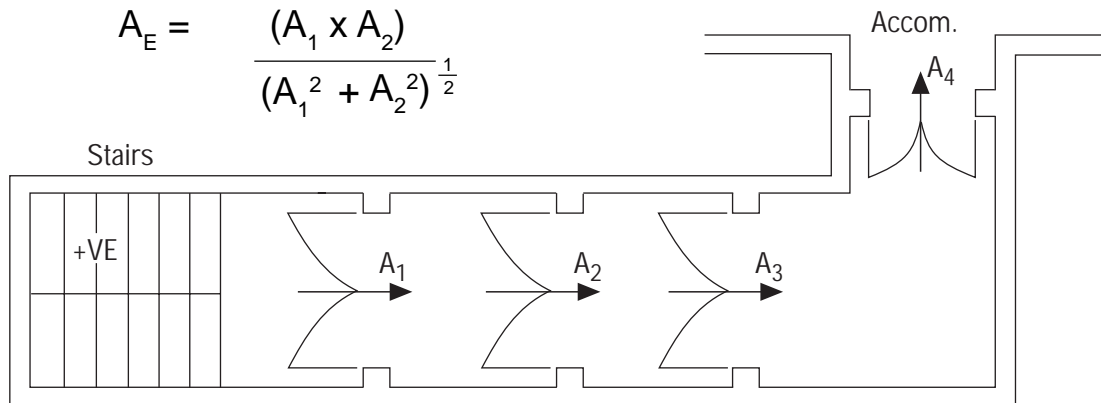

Fig 15 - Doors In Series

Although we can estimate the effective area for an escape route in this way, there are always, in any building, other 'leaks we are not aware of'.

To accommodate these, the air supply volume calculated should be increased by at least 50%, stipulated by the CODE OF PRACTICE.

4.5 OPEN DOOR VELOCITY

When a large opening, eg the opening of a door occurs, then these design pressures cannot be maintained.

In this situation smoke can be held back from the escape routes if the AIR VELOCITY through the open door, out of the pressurised space, is sufficiently high.

There are two possible occasions when the Pressurisation System has to control the smoke by VELOCITY. Both these are specified in the U.K. Code of Practice.

a) Means of Escape

Whilst people are escaping the building it is inevitable that doors will be open, albeit intermittently. BS5588: Part 4: 1998 specifies an air velocity of 0.75m/sec through the open door(s) onto the fire floor for all classes of escape systems (velocity criterion). In addition the requirements of Class "C", "D" and "E" Systems demand a minimum pressure difference of +10Pa across the **closed** door(s) onto fire floors (pressure criterion).

Fig. 7 to 9 inclusive detail this later requirement.

This **pressure criterion** is likely to produce the highest demand for supply air on Class C systems, and occasionally on Class E & F systems using power exhaust from the Fire Floor.

b) Fire Fighting

During fire fighting the **Fire Brigade** need to open doors on the fire floor to gain entry without themselves being engulfed in smoke. The code of practice specify that an **Air Velocity** of 2.0m/sec is needed to achieve this.

The air supply for all these cases is usually greater than that required to develop the 50Pa pressure requirement of the detection phase (Mode 1).

Therefore, to prevent the **Pressure** in the staircase etc. rising to a level where it becomes difficult or impossible, for occupants to open doors onto the escape route, the air supply system must be capable of air volume variation.

The maximum allowable door opening force is limited by the new Code of Practice to 100 Newton applied at the door hand. To achieve this maximum design pressure of +60Pa is recommended.

4.6 REQUIREMENTS OF A PRESSURISATION SYSTEM

a) A Pressurisation System designed to protect an escape route used only for MEANS OF ESCAPE is required to develop 50 Pa Pressure in the escape route when all the doors are closed, and up to 0.75 m/sec VELOCITY through the open door on the fire floor, OR a pressure, difference of +10PA across the closed fire floor door, whichever is greater, under conditions, illustrated Figs 5, 7 8 and 9.

b) A Pressurisation System designed to protect an escape route which is to be used both for MEANS OF ESCAPE and FIRE FIGHTING is required to achieve a VELOCITY of 2 m/sec through the open door on the fire floor under the conditions illustrated by Fig 6, in addition to the requirements specified in (a) above.

c) A Pressurisation System must include a low resistance path to enable the pressurising air to escape from the unpressurised areas of the building - discussed in 2.3.

If mechanical exhaust is used then the FANS must be capable of handling the hot smoke involved and comply with the requirements of BS7346 Part 2.

Here then are the simple tools which allow us to establish the AIR SUPPLY and EXHAUST requirements of a PRESSURISATION SYSTEM for SMOKE CONTROL. They will apply to any combination of PRESSURE or DOOR VELOCITIES SPECIFIED IN THE VARIOUS NATIONAL Codes of Practice.

CHAPTER 5

Fan Selections

5.1 WORKED EXAMPLE

The best method for establishing the requirements of SUPPLY FANS for pressurisation systems is to select the fans for a typical pressurised staircase.

The example chosen is perhaps the simplest form of a Pressurised Staircase for Smoke Control, and as such may be unreal. However, using a simple example, it is easier to determine and highlight the fan requirements.

Example: A Staircase, Fig 16 serves 6 floors. There is a double door to outside at ground level and single doors into the accommodation on each floor.

5.2 CALCULATION PROCEDURE

A complete and detailed calculation procedure, with worked examples, is outlined in BS5588 Part 4:1998. Designers should follow this approach when seeking approval for their schemes.

With the possible exceptions outlined in paragraph 4.5(a) the size of the supply fan for pressurisation system is determined by the velocity through the open door (s) - MODE 2 or MODE 3. The airflow requirements of MODE 1 and are then achieved by either:-

- a) Wasting the excess air to atmosphere or
- b) Reducing the volume flow of the fan.

The worked example in this paper employs a much simplified method of calculation developed and used by Mr C. H. Moss (Ref 10). This method is very useful when sizing and selecting the supply air fan (s). It will always over estimate the air supply requirements by:-

a) The addition of 50% to the calculated air-flows at MODE 1.

b) Assuming that, when the door(s) as specified, are open (MODE 2 AND MODE 3), the pressure of 50 Pa is maintained in the staircase and lift lobbies.

However, buildings in general, and staircases in particular are notoriously 'leaky'. Equally, incorrect and ill-fitting doors would increase the airflow demands. Over sizing the supply fan at the design stage can prove beneficial during commissioning.

This highlights one of the requirements of a supply air fan - that it's air volume output be easily adjustable on site. Axial flow fans with variable geometry impellers meet this requirement.

5.3 EXHAUST AIR FANS

The sizing of any EXHAUST AIR FANS will also be determined from the system calculation procedure. These fans must be capable of handling hot air smoke and comply with BS7346 - Part 2 (Ref 2) or similar testing standard.

BS5588 - Part 4: 1998 recommends that exhaust air fans be capable of surviving

600°C for 2 hours in unsprinklered buildings
300°C for 2 hours in sprinklered buildings.

At the time of writing neither of these specifications are in line with the high temperature categories specified in BS7346 Part 2 or the Hence designers are recommended to seek clarification from Building Control.

5.4 PRESSURISED STAIRCASE ONLY

MODE 1 (B5588 Part 4 - 1998)
ALL SYSTEMS ALL DOORS CLOSED

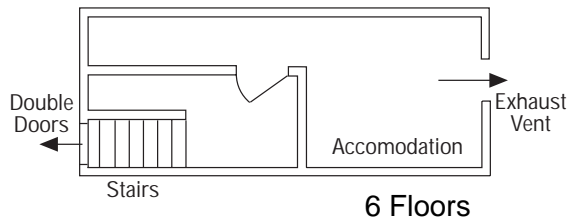

Fig 16- Plan of Staircase

$$A = 1 \times \text{double door at } 0.03 = 0.03 \text{ m}^2$$

$$6 \times \text{single doors at } 0.01 = \frac{0.06 \text{ m}^2}{0.09 \text{ m}^2}$$

$$Q = 0.83A_E P^{1/2}$$

$$= 0.83 \times 0.09 \times 50^{1/2} = 0.53 \text{ m}^3/\text{sec}$$

Increase by 50% + 0.26 m³/sec

$$\text{Say } \mathbf{0.80 \text{ m}^3/\text{sec}}$$

MODE 2 (BS5588 Part 4 - 1998)
CLASS A SYSTEMS ESCAPE

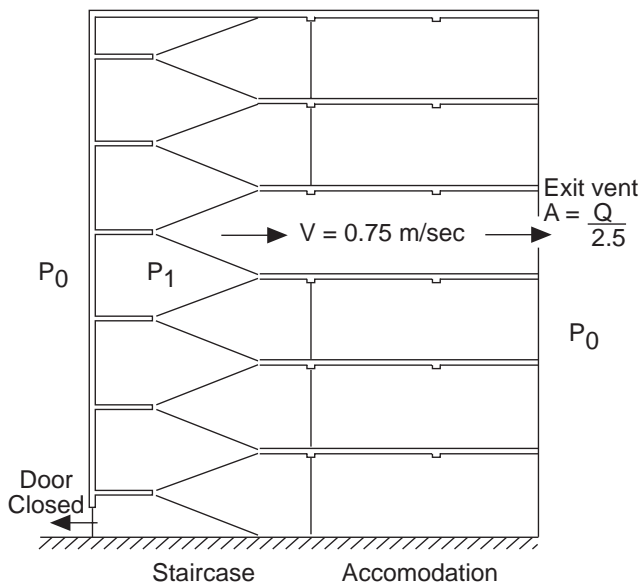

Fig 17

$$A = \text{Area of single leaf door} = 2.0 \text{ m} \times 0.8 \text{ m} = 1.6 \text{ m}^2$$

$$V = \text{Velocity through door} = 0.75 \text{ m/sec}$$

$$Q = V \times A = 0.75 \times 1.6 = 1.20 \text{ m}^3/\text{sec}$$

Add MODE 1 = 0.80 m³/sec

$$\mathbf{2.00 \text{ m}^3/\text{sec}}$$

a) To calculate pressure required in stairwell to exhaust 1.2 m³/sec to atmosphere via fire floor (see fig 17).

$$\text{Area of single leaf door} = 2.0 \times 0.8 = 1.6 \text{ m}^2$$

$$\text{Area of exhaust vent} = 1.2/2.5 = 0.48 \text{ m}^2$$

$$A_E = \left[\frac{1}{A_1^2} + \frac{1}{A_2^2} \right]^{-1/2} = \left[\frac{1}{1.6^2} + \frac{1}{0.48^2} \right]^{-1/2}$$

$$= \mathbf{0.46 \text{ m}^2}$$

$$P_1 = \left[\frac{Q}{0.83 \times A_E} \right]^2 = \left[\frac{1.2}{0.83 \times 0.46} \right]^2$$

$$= \mathbf{10.01 \text{ Pa}}$$

This is more than covered by 50 Pa assumed.

b) To calculate area of Pressure Relief.

$$\text{Quantity of air to be wasted} = (2.0 - 0.8) = 1.2 \text{ m}^3/\text{sec}$$

$$\text{Area of Pressure Relief} = \frac{Q}{0.83 \times P^{1/2}}$$

$$= \frac{1.2}{0.83 \times (50)^{1/2}} = \mathbf{0.204 \text{ m}^2}$$

MODE 2 CLASS E SYSTEM ESCAPE
PRESSURE CRITERION

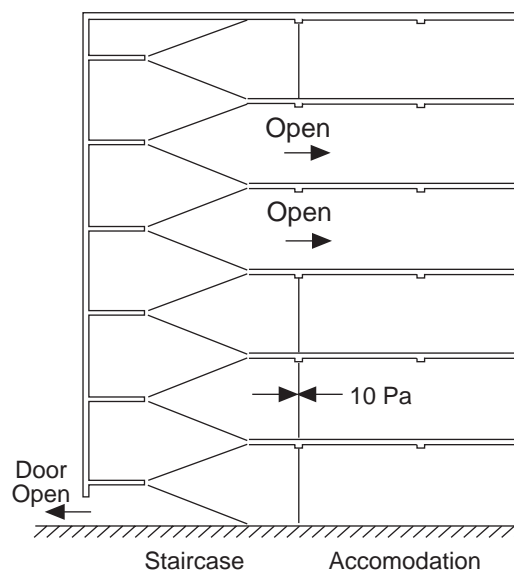

Fig 18

a) To calculate the airflow through open door to outside with 10Pa pressure in stairwell.

$$Q = 0.83 A_E P^{1/2}$$

$$= 0.83 \times 1.6 \times 10 = 4.20 \text{ m}^3/\text{sec}$$

b) To calculate airflow through open accommodation door with 10Pa pressure in stairwell an assumed and 0.22m² area of leakage from each floor. (see Fig 17 and note below).

$$A_E = \left[\frac{1}{A_1^2} + \frac{1}{A_2^2} \right]^{-1/2} = \left[\frac{1}{1.6^2} + \frac{1}{0.22^2} \right]^{-1/2}$$

$$= 0.217 \text{ m}^2$$

$$Q = 0.83 A_E P^{1/2}$$

$$= 0.83 \times 0.217 \times 10^{1/2}$$

$$= 0.57 \text{ m}^3/\text{sec}$$

Note: The accommodation on each floor is assumed to be an open plan office - 900 m² in area x 3m high. From Table D3 in BS5588 - Part - 1998, using average leakage via the floors and loose leakage walls, the leakage area from the accommodation on one floor would be 0.22m².

c) To calculate airflow required to maintain the Pressure Criterion.

Through open exit door	= 4.20 m ³ /sec
Through (2 off) open accommodation doors	= 1.14 m ³ /sec
Add MODE 1	= 0.80 m ³ /sec
	6.14 m³/sec

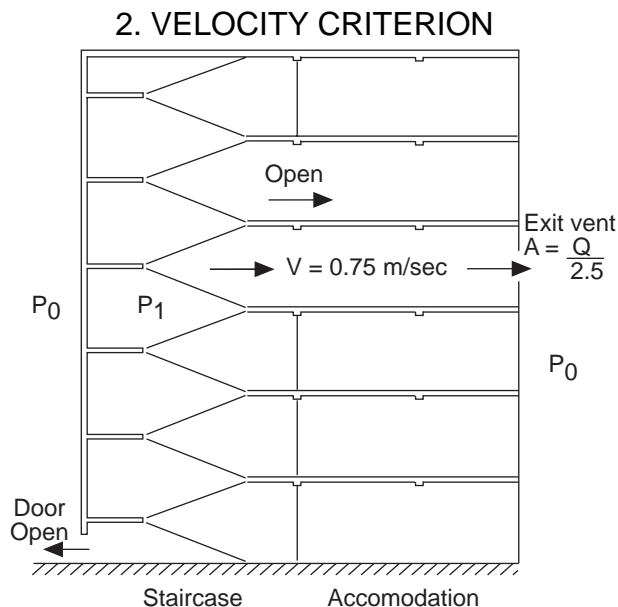

Fig 19

a) To calculate airflow through open fire floor door.

A = Area of single leaf door	= 2.0 x 0.8 m	= 1.6 m ²
V = Velocity through door	= 0.75 m/sec	
Q = A x V = 1.6 x 0.75		= 1.20m ³ /sec

b) To calculate pressure required in stairwell to exhaust 1.2 m³/sec to atmosphere via fire floor. (Fig 18)

Area of single leaf door	= 1.6 m ²
Area of exhaust vent from fire floor	= 0.48 m ²

$$A_E = \left[\frac{1}{A_1^2} + \frac{1}{A_2^2} \right]^{-1/2} = \left[\frac{1}{1.6^2} + \frac{1}{0.48^2} \right]^{-1/2}$$

$$= 0.458 \text{ m}^2$$

$$P1 = \left[\frac{Q}{0.83 \times A_E} \right]^2 = \left[\frac{1.2}{0.83 \times 0.458} \right]^2$$

$$= 10.01 \text{ Pa}$$

(Say 10 Pa)

c) To calculate airflow through open door to outside with 10Pa Pressure in stairwell.

$$Q = 0.83 A_E P^{1/2}$$

$$= 0.83 \times 1.6 \times 10^{1/2} = 4.20 \text{ m}^3/\text{sec}$$

d) Airflow through open accommodation door with 10Pa pressure in stairwell - (from PRESSURE CRITERION as above) = 0.57 m³/sec

e) To calculate airflow required to maintain the VELOCITY CRITERION

Through open fire floor door	= 1.20m ³ /sec
Through open exit door	= 4.20m ³ /sec
Through open accommodation door	= 0.57m ³ /sec
Add MODE 1	= 0.80m ³ /sec
	= 6.77m³/sec

Note Velocity Criterion dominates

f) To calculate area of Pressure Relief

Quantity of air to be wasted	= (6.767-0.800)	= 5.97m ³ /sec
Area of Pressure Relief	= $\frac{Q}{0.83 \times (P)^{1/2}}$	= $\frac{5.97}{0.83 \times (50)^{1/2}}$
		= 1.02m²

MODE 3 - CLASS B SYSTEMS - FIRE FIGHTING
(BS5588 Part: 4 - 1998)

A = Area of single leaf door
= 2.0 m x 0.8 m = 1.6 m²
V = Velocity through door = 2.0 m/sec
Q = Through open door on fire floor
= 1.6 x 2.0 = 3.20 m³/sec

a) To calculate pressure required in stairwell to exhaust 3.2 m³/sec to atmosphere via fire floor (Fig 20).

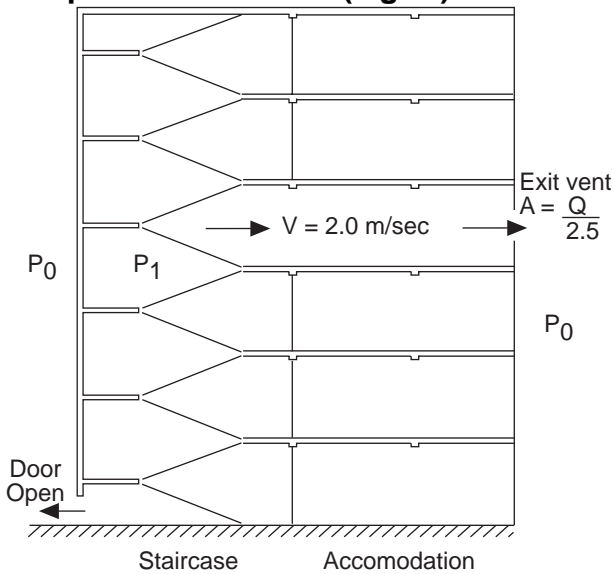

Fig 20

Area of single leaf stair/fire room door
= 1.6 m².
Area of exhaust vent from fire room
= 3.2/2.5 = 1.28 m²

$$A_E = \left[\frac{1}{A_1^2} + \frac{1}{A_2^2} \right]^{-1/2} = \left[\frac{1}{1.6^2} + \frac{1}{1.28^2} \right]^{-1/2}$$

$$= 1.0 \text{ m}^2$$

$$P = \left[\frac{Q}{0.83 \times A_E} \right]^2 = \left[\frac{3.2}{0.83 \times 1.0} \right]^2$$

$$= 14.8 \text{ Pa (SAY 15 Pa)}$$

b) To calculate volume air flow through open door to outside with 15 Pa pressure in stairwell.

$$Q = 0.83 A_E P^{1/2}$$

$$= 0.83 \times 1.6 \times 15^{1/2} = 5.14 \text{ m}^3/\text{sec}$$

c) To calculate volume air required to maintain 2.0 m/sec through open door on fire floor.

Q = Through open door on fire floor
= 1.6 x 2.0 = 3.20 m³/sec
Through open door to outside = 5.14 m³/sec
Add MODE 1 = 0.80 m³/sec
9.14 m³/sec

d) To calculate area of Pressure Relief.

Quantity of air to be wasted =
(9.14 - 0.8) = 8.34 m³/sec

$$\text{Area of Pressure Relief} = \frac{Q}{0.83 \times (50)^{1/2}}$$

$$= \frac{8.34}{0.83 \times (50)^{1/2}}$$

$$= 1.421 \text{ m}^2$$

5.5 SUMMARY OF FAN DUTY REQUIREMENTS

Supply (with Natural Exhaust)

Escape Only Staircase - **Class A System**
2.0 m³/sec at 50 Pa + System Losses
0.204 m² of Pressure Relief.

Escape only stair - **Class E system**
6.769 m³/sec at 50 Pa + system losses
1.02m² of Pressure Relief

Fire Fighting and Escape Staircase - **Class B system**
9.14 m³/sec at 50 Pa + System Losses
1.43 m² of Pressure Relief.

Exhaust

Escape Only Staircase -
1.2 m³/sec at exhaust system losses
or 0.48 m² of Natural Vent per Floor.

Fire Fighting and Escape Staircase -
3.2 m³/sec at exhaust system losses
or 1.28 m² of Natural Vent per Floor.

5.6 POWERED EXHAUST

The air duty requirements detailed at Paragraph 5.5 are calculated with the pressurising airflow exhausting from the fire floor through a natural vent. This results in an increased airflow through the open fire door to outside.

Fan powered exhaust would eliminate the need for this increase in the supply fan duty. The exhaust air fan could be selected to produce zero pressure on the fire floor.

Hence, for the example shown, the supply air fan would be sized to deliver 7.2 m³/sec for MODE 3 (reduced from 9.14 m³/sec). The exhaust air fan would need to handle 3.2 m³/sec.

The amount of air to be wasted via the pressure relief damper would fall to 6.4 m³/sec, thereby reducing the size of the PRESSURE RELIEF DAMPER from 1.43 m² to 1.09 m².

5.7 SUPPLY FAN UNIT SELECTIONS (Natural Exhaust)

These take the form of fan performance charts onto which the calculated airflow requirements have been plotted.

Curves Pa-1, Pa-2 and Pa-3, also shown on the FAN CHARTS, are the system resistance curves for MODES 1, 2 and 3 respectively.

5.7.1 Pressurised Staircase - Escape Only

CHART 1 illustrates a fan engineering solution to this problem viz:-

a) The supply air fan size is determined by the air duty requirements of MODE 2 (2.0 m³/sec). Fan selected is Woods JM Aerofoil - 40 JM/16/2/28. At 2.0 m³/sec this fan will develop a pressure of 250 Pa, leaving 200 Pa available to overcome the resistance of the air system.

b) Without a PRESSURE RELIEF DAMPER, the fan selected would develop about 360 Pa, (Point A) in the staircase with all doors closed (MODE 1). This is well above the 60 Pa allowable and would be unacceptable.

c) The calculations show that to maintain 50 Pa maximum, 1.2 m³/sec of the supply air has to be wasted through a pressure relief damper 0.204 m² in area (Dimension X). However to allow for the change in the fan working point, (Point B), when all doors are closed the air wasted will increase to 2.25 m³/sec requiring a damper 0.256 m² in area (Dimension X + Y).

Chart 1

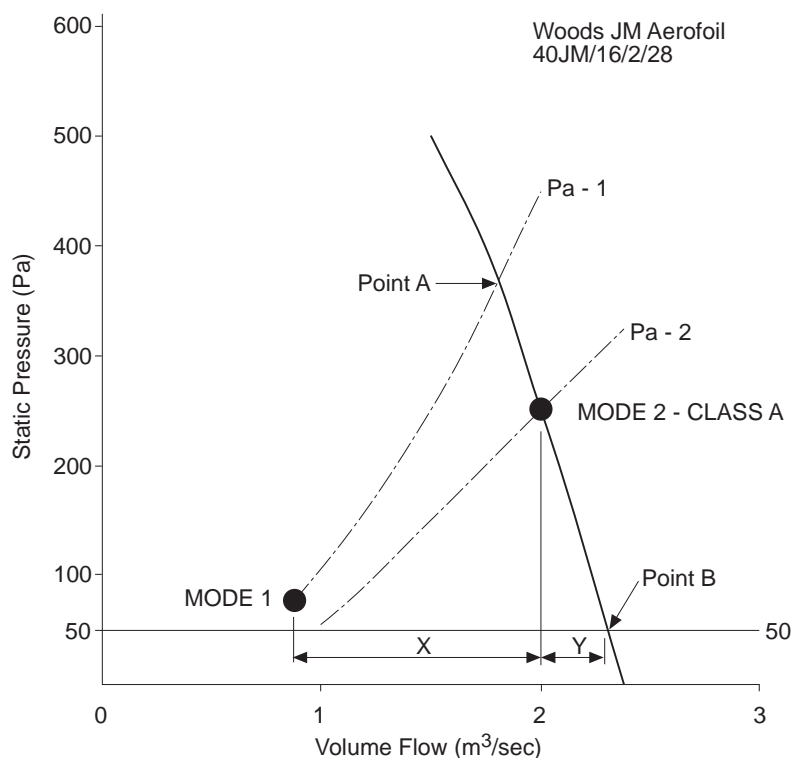

This excess becomes of increased importance on system with high resistance ductwork systems, **and demonstrates the need for supply fan to have steep VOLUME/PRESSURE performance characteristics (Axial Flow Fans in preference to Centrifugal).**

5.7.2 Pressurised Staircase - Fire fighting & Escape

CHART 2 illustrates one solution to this problem:-

Chart 2

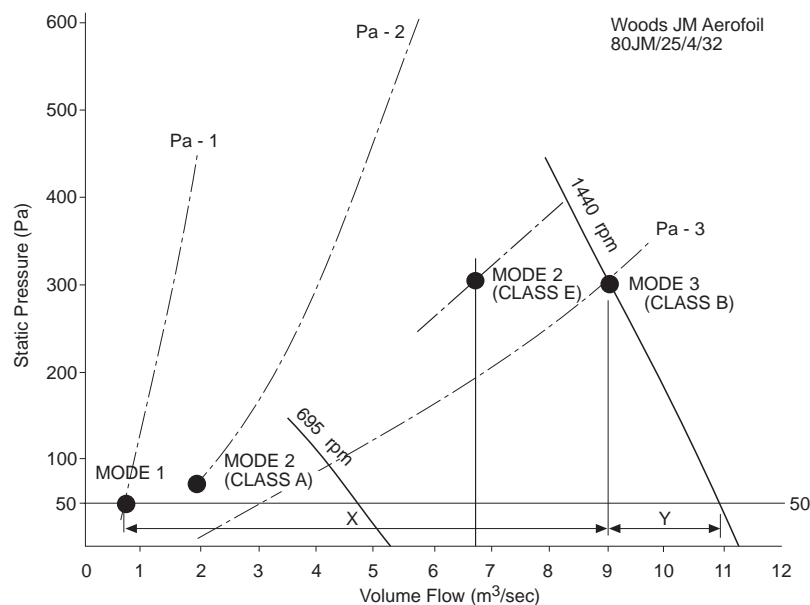

- a) The supply air fan size is determined by the air duty requirements of MODE 3 (9.14 m³/sec). Fan selected is Woods JM Aerofoil - 80JM 25/4/9/32. At 9.14 m³/sec this fan will develop a pressure of about 300 Pa., leaving 250 Pa available to overcome the system resistance.
- b) Without a PRESSURE RELIEF DAMPER the fan would stall when all the doors were closed resulting in an indeterminate pressure in the staircase but a pressure likely to be above 60 Pa maximum.
- c) To maintain 50 Pa Maximum, 8.34 m³/sec (Dimension X) needs to be wasted through a damper 1.43 m² in area. This will increase to 1.75 m² when allowance is made for the change in the fans working point (Dimension X + Y).

d) To achieve a reduction in the area of the Pressure Relief Damper the FAN SPEED could be reduced to 695 rpm providing more than sufficient airflow to meet the Detection Phase (Mode 1) requirement.

As Chart 2 shows, at this lower speed the fan will develop a much reduced pressure, and there could be situations when this would be insufficient to meet the requirements of the system.

This highlights a possible danger of using speed control as a means of meeting the demands of a pressurisation system and should be used with care.

CHART 3 illustrates a second solution to the problem described under paragraph 4.7.2.

Here the size of the Pressure Relief Damper is reduced by operating two Woods JM Aerofoils 50 JM/20/2/6/30, (smaller fans), in parallel. Both fans would run to provide the requirements of Mode 3 - (9.14 m³/sec). One fan only would be run during the Detection Phase (Mode 1)

The amount of air to be wasted would now reduce to 4.8 m³/sec (Dimension X + Y) demanding a pressure relief damper 0.82 m² in area.

The fan speed is maintained eliminating the dangers inherent with speed reduction.

Chart 3

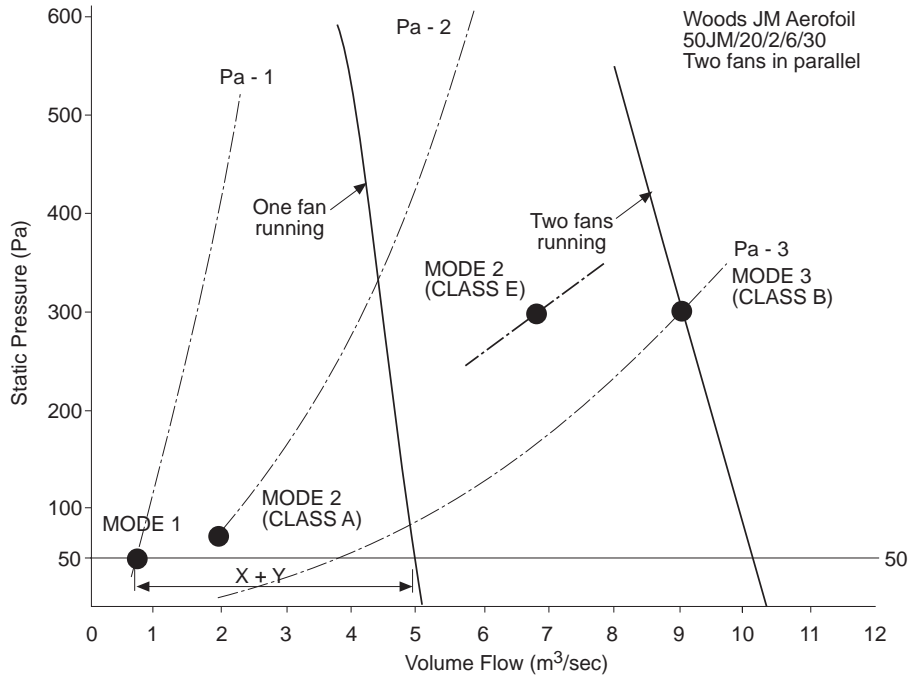

CHART 4 illustrates a third possible solution to the problem described in Paragraph 4.7.2

The 9.14 m³/sec required for MODE 3 is met by using a Woods Varofoil - variable pitch in motion fan - 80KG40A-4-6. The air duty requirements of MODES 1 and 2 are then achieved by reducing the pitch angle of the fan.

The size of the Pressure Relief Damper is now greatly reduced, but not eliminated. In

the example shown the air to be wasted would be 2.0 m³/sec (Dimensions X + Y) and would demand a damper 0.34 m² in area.

Again the fan speed is maintained eliminating the dangers inherent with fan speed reduction. As an added advantage, using Varofoil, the fan will tend to correct for any unidentified leakage etc in the staircase and system.

Chart 4

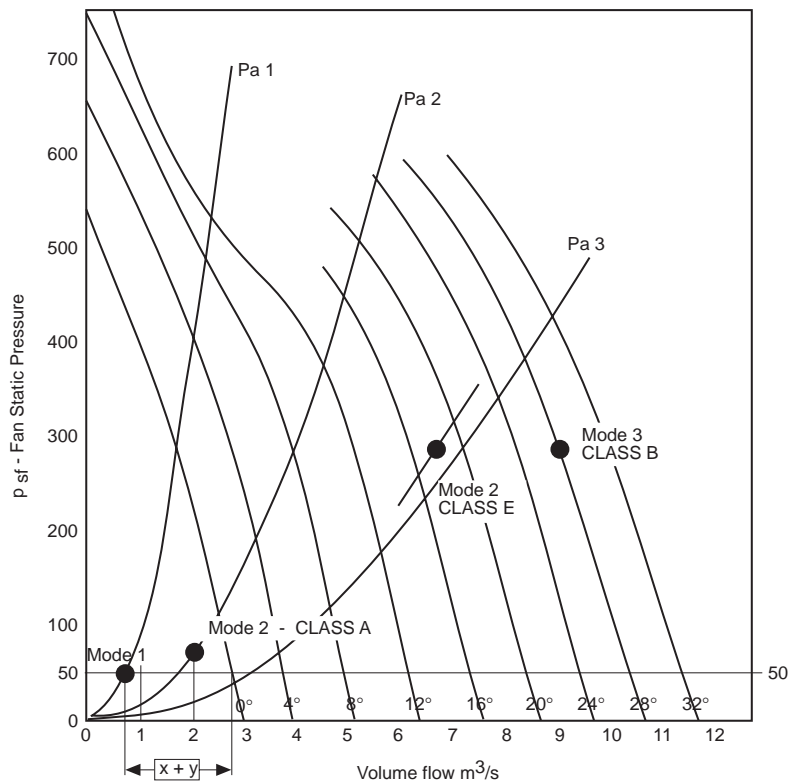

CHAPTER 6

Fans for Pressurisation Systems

6.1 REQUIREMENTS OF A PRESSURISATION FAN

The requirements of both SUPPLY and EX-HAUST fans in Pressurisation Systems can be listed as follows:-

- a) Supply Air Fans must be capable of volume variation to meet the demands of all three operating modes of the system. This is discussed in more details under paragraph 6.2
- b) Supply Air Fans must be capable of duty changes on site, to compensate for any under or over sizing inherent in the design procedure.
- c) Supply Air Fans should have a steep volume/pressure curve to limit the air wastage through the pressure relief damper - and hence its size.
- d) Supply Air Fans should maintain a high pressure capability ensuring that sufficient pressure is always available to the system. The use of variable speed fans to obtain the air volume changes needs expert advice.
- e) Exhaust Air Fans must be capable of handling the hot fire smoke at 600 °C in unsprinklered, and 300°C in sprinklered buildings. They should comply with BS7346 Part 2 or similar testing standard.
- f) Fans should be lightweight, vibration free and easy to install.
- g) All fans must be reliable in operation and be provided with complete and adequate maintenance instructions. They should be manufactured by companies who are certified to Quality Assurance System BS EN ISO 9001 or equal.

6.2 PROVIDING FOR VARIABLE AIR DUTY

Within the limits imposed by the general requirements of a supply air fan, providing for variable air duty can best be achieved by one of the following methods.

- a) A Constant Speed - Single fan with pressure relief damper.
- b) Constant Speed - Twin fan with pressure relief damper - varying the number of fans operating.
- c) Variable Speed Fans.
- d) Constant Speed - Variable pitch in motion fans (Varofoil).

Constant speed fans ensure that the maximum pressure capability of the fan is available at all three operating modes of the system.

With variable speed fans this will not be the case. The pressure developed by the fan varies with the speed squared. If the speed of the fan is halved to achieve the lower air duty requirements of MODES 1 and 2, then the pressure development is reduced by four times.

The result could be insufficient pressure being available at the lower speed to provide for the 50 Pa Mode One requirement and to overcome the resistance of the system ductwork. This could lead to the fan operating in an unstable stall condition.

6.3 STAND-BY FANS

The need for STAND-BY FANS in a Pressurisation System is a function of two considerations.

- a) The degree of fire risk.
- b) The reliability of the fan equipment.

The degree of fire risk must of course be determined by the relevant fire and building control authorities.

The reliability of the fans is under the control of fan manufacturers and building owners, the latter having responsibility for ensuring correct and adequate maintenance.

Hobson and Stewart investigated the reliability of fan equipment as part of their research (Ref 6). In 1972 they found that AXIAL FLOW FANS - direct driven - had a failure rate of 0.052 per year and a reliability of 94.9%. A system using STAND-BY FANS to provide 100% backup would increase this reliability to 99.8%. For comparison the same figures for belt driven CENTRIFUGAL FANS were 0.5 failures per year! 50% and 91% reliability respectively.

They concluded that direct driven AXIAL FLOW FANS were more reliable, and the need for STAND-BY FANS was not objectively necessary to achieve a high level of plant reliability in the event of a fire.

However, in spite of these findings, they recognised that, in FIRE SAFETY SYSTEMS, "RELIABILITY is of PARAMOUNT IMPORTANCE" and warranted the provision of STAND-BY FANS.

Since 1984 Quality Control throughout the British fan manufacturing industry has improved with the introduction of a BS EN ISO 9001 (formally BS5750) registered firm scheme. One of the important requirements of all fan equipment used in FIRE SAFETY systems is that it should be manufactured by companies who are registered and certified to BS EN ISO 9001. Building Control Authorities should insist on these STANDARDS.

BS5588: Part 4: 1998 Specifies that STANDBY FANS and equipment be provided on all pressurisation systems designed for smoke control - both Supply Fans and Exhaust Fans.

Axial flow fans can be mounted in SERIES or PARALLEL to provide this STAND-BY requirement.

6.4 CONCLUSIONS

Smoke control using pressure differential has been described as -

Simply in Concept but Difficult in Practice (Ref 11).

The discussion in this paper shows that current fan engineering technology is well able to provide the requirements of both SUPPLY and EXHAUST AIR FANS of a PRESSURISATION SYSTEM for SMOKE

APPENDIX ONE

References

1. J.A. Wild Fans for Fire Smoke Venting Woods Air Movement Ltd
Technical Paper WTP20
June 1989 (revised Nov. 1990)
2. J.H. Klote An overview of Smoke National Bureau of Standards.
Control Technology Paper NBSIR 87-3626 1987.
3. P.H. Thomas Movement of Smoke in Institution of Fire Engineers
Horizontal corridors Vol. 30 No. 72 1970.
against an airflow.
4. G.A.C. Courtier The development of Axial Flow Institution of Mechanical
J.A. Wild Fans for the venting of Engineers Paper C401/016
hot fire smoke. March 1990.
5. BS7346 Part 2 Specification for powered smoke British Standards Institution
and heat exhausters. 1990.
6. P.J. Hobson Pressurisation of Escape Routes Fire Research Note 958
L.J. Stewart in Buildings. December 1977.
7. BS5588 Part 4 Fire Precautions in the design of British Standards Institution
buildings. Smoke control in prote- 1978
cted escape routes using
pressurisation.
8. BS5588 Part 4 Fire Precautions in the design, British Standards Instiution
contruction and use of buildings. 1998
Code of practice for smoke control
using PRESSURE DIFFERENTIALS.
9. BS5588 Part 5 Fire Precautions in the design, British Standards Institution
construction and use of buildings. 1991.
Code of Practice for Fire
Fighting stairs and lifts.
10. C.H. Moss Pressurisation Systems using air Seminar at Woods of
movement technology as a Colchester Ltd.
Fire Safety Measure. February 1993.
11. E.G. Butcher Pressurisation - Fire Surveyors October 1993.
A.C. Parnell Simple in Concept
Difficult in Practice.

This document has been produced as a general guide and its contents should not be construed as any representation on our part as to the quality or fitness of our products for any particular purpose, nor as providing advice on the design of fire and smoke control systems. You are recommended to consult your professional advisers on matters relating to the design and installation of any such systems.